

PQ1 Power Quality Sensor

General Description

The PQ1 Power Quality Sensor detects power quality problems on standard AC power mains.

It is a single-phase monitor that can also be used phase-to-phase or phase-to-neutral on three-phase power systems.

The PQ1 costs less than one-tenth as much as traditional power quality monitors. It quickly pays for itself by reducing service calls on automatic manufacturing systems, semiconductor tools, medical equipment, elevator controls, and other complex systems.

You can select one of 16 pre-programmed industry-standard depth/duration response curves, covering voltage sags, swells, high-frequency impulses, and power interruptions.

Features

- Very low cost
- Detects sags/dips, swells, interruptions, impulses
- Simple to install - AC in, relay contacts out
- Captures impulses as short as 500 nanoseconds
- 0,5% typical accuracy
- Automatically adjusts to 50Hz, 60Hz, or 400Hz
- Direct connection to 100 Vrms ~ 240 Vrms
- Can be used at 277 Vrms ~ 600 Vrms with external step-down transformer
- Built-in international power quality standards
- No software required, no computer required

Applications

- Semiconductor manufacturing tools
- Medical laboratory equipment
- SCADA systems, PLC systems
- Elevator controls
- Ultra-low-cost substation power quality monitoring
- Machine tools, HVAC controls, ASD's
- Servers and data centers, telecom centers



Combine three PQ1's for 3-phase applications



Compact power quality sensor for quick integration into your system. DIN-rail or panel mount. Quick installation: just connect power, dial in the nominal voltage, and set the threshold switch to "Standard".

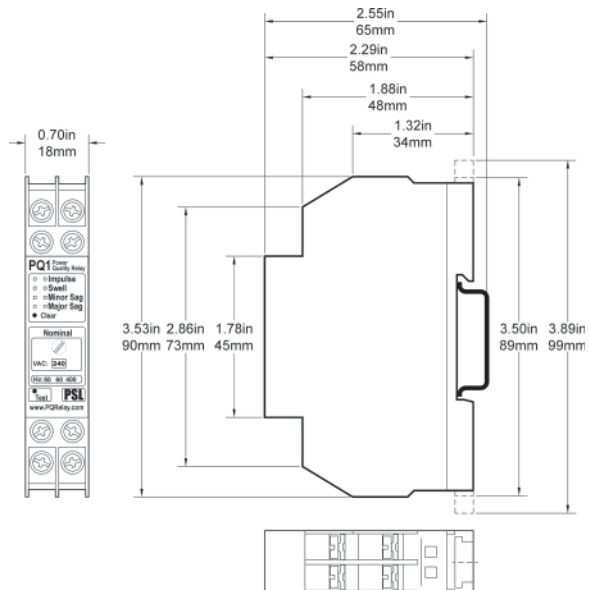

PQ1 Operation

Displaying and clearing events



When a power quality event occurs, the red light will blink for 3 seconds (or longer, if the event continues for longer than 3 seconds). The yellow 'event history' light will turn on and will remain on. The PQ1 will remember the state of these yellow 'event history' lights even if power is removed. Push the Clear button to clear these yellow 'event history' lights. The Clear button also re-checks the nominal voltage and frequency.

Verifying correct operation

Push and hold the Clear button for 1 second. The PQ1 will generate one power quality event of each type. Each pair of relay contacts will also open while the associated event light is flashing. After the test, the PQ1 automatically clears all events, and re-checks the nominal voltage and frequency. Use this test to verify that your system responds properly when the PQ1 detects a power quality disturbance.

Choosing the nominal voltage



Set the nominal voltage with this rotary switch. When the PQ1 is powered up, it first checks to see if the voltage is within $\pm 30\%$ for your nominal voltage setting. If not, this window will flash red, telling you to check your nominal voltage setting. Power quality event triggering is based on a percentage of this setting. Your choices are: 100V, 110V, 120V, 200V, 208V, 220V, 230V, 240V.

Nominal frequency is set automatically



When the PQ1 first receives AC power, it searches for the nominal frequency. If the nominal frequency is neither 50 Hz, 60 Hz, nor 400 Hz, the PQ1 will continue searching for the nominal frequency, and the frequency lights will continue to hunt. Once the PQ1 finds the correct frequency, you will see a green heartbeat on this display.

Choosing power quality event thresholds

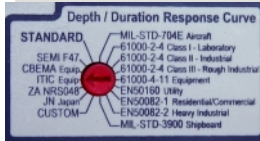

Choose one of the depth-duration response curves to select the thresholds at which the PQ1 will signal a swell, minor sag, or major sag event. (The impulse threshold will be the same regardless of which response curve you select.) If you're not sure, set this switch to the "STANDARD" position.

Connecting power and relay contacts





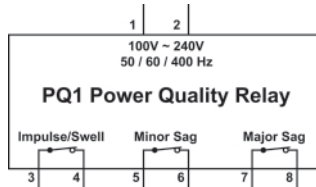

Connect the pair of AC power screw terminals to any phase-to-neutral or phase-to-phase voltage from 100 Vrms to 240 Vrms (or use a step-down transformer for higher voltages).

The PQ1 has three pairs of normally-closed dry relay contacts: Swell / Impulse, Minor Sag, and Major Sag. These contacts will open for at least 3 seconds during each power quality event, and will automatically re-close at the end of the event. The contacts are rated for 30V max, 300 mA max. You can connect them just like any switch contact: use them to control relays, to activate alarms, to trigger inputs on your computer system, or to insert entries in your system's error log.



Symbol Markings

Symbol	Explanation
	Consult documentation – potential hazard. Lisez la documentation -- risque possible. Lesen Sie die Unterlagen. Mögliche Gefahr. Lea la documentación. Peligro posible.
	Caution. Risk of electric shock. Attention. Risque de décharge électrique. Vorsicht. Gefahr des elektrischen Schlages. Precaución. Riesgo de la descarga eléctrica.
	Fuse Fusible Sicherung Fusible

 **CAUTION:** If the PQ1 is used in a manner not specified by the manufacturer, the protection provided by the equipment may be impaired.

PQ1 - General specifications

	Minimum	Typical	Maximum	Notes
Nominal AC voltage	100 Vrms	--	240 Vrms Higher voltages possible with external step-down transformer	<ol style="list-style-type: none"> Standard levels: 100 / 110 / 120 / 200 / 208 / 220 / 230 / 240 Vrms. May be installed phase-to-neutral or phase-to-phase, provided nominal voltage is in range. CAT II installation. 50 / 60 / 400 Hz If an external step-down transformer is used, impulse threshold accuracy may be degraded.
Nominal AC current	---	< 10 mA	< 100 mA	<ol style="list-style-type: none"> Maximum current occurs during rapid voltage increase. Current is non-sinusoidal and non-symmetrical.
Relay contact outputs	--	--	300 mA, 30 V AC or DC	<ol style="list-style-type: none"> Relay outputs are dry contacts. Contacts open when a problem is detected. Minimum duration that contacts will be open is 3 seconds, regardless of the event duration. Maximum duration that contacts will be open is the event duration plus the duration threshold.
Relay contact isolation from AC input	1500 Vrms	--	--	<ol style="list-style-type: none"> Provides "Basic Insulation" per IEC 61010. Measured between AC input terminals (1 and 2 connected together) and all relay contact terminals (3,4,5,6,7, and 8 connected together)
Environmental:				<ol style="list-style-type: none"> Designed for indoor use. Install fully enclosed in a grounded (earthed) recognized metal enclosure.
Temperature	0°C	---	50°C	<ol style="list-style-type: none"> Max relative humidity 80% at up to 31°C decreasing linearly to 50% at 40°C.
Max. Rel. Humidity	---	---	80% @ 31°C	<ol style="list-style-type: none"> Transient overvoltage Category II: local level, appliances, portable equipment, etc. Pollution Degree 1: No pollution or only dry, non-conductive pollution occurs.
Maintenance	---	---	---	<ol style="list-style-type: none"> There are no user-serviceable parts in the PQ1. The fuse is type T100mA 240V, and is factory-replaceable. There are no cleaning instructions for the PQ1.

PQ1 - Accuracy

	<i>Minimum</i>	<i>Typical</i>	<i>Maximum</i>	<i>Notes</i>
RMS voltage thresholds	--	±0,5% FS	±1,5% FS	<ol style="list-style-type: none"> 1. RMS calibrated. 2. Sensed differentially as digital positive-peak-sense-equivalent, referenced to Terminal 1. Voltage harmonics may affect RMS accuracy, but any effect mimics the effect on an electronic load. 3. IEC 61000-4-30 Class B 4. Accuracy specified at 50/60/400 Hz 5. 300 Vrms full scale
Duration thresholds	--	±0,5 cycle	±1 cycle	<ol style="list-style-type: none"> 6. Duration thresholds are specified in milliseconds, but uncertainty is specified in cycles, e.g. a 100 millisecond duration threshold at 50 Hz (20 millisecond cycle) is 100 milliseconds ± 20 milliseconds. 7. Applies to sag and swell thresholds.
Impulse threshold	400 Vpk	450 Vpk	500 Vpk	<ol style="list-style-type: none"> 8. Nominal impulse threshold is fixed at 450V pk, regardless of nominal voltage, unlike sag and swell thresholds which are expressed in percent of nominal. 9. Specified for positive 1.2 x 50 uS impulse, per IEC 61000-4-5 10. Useful response from 500x10⁻⁹ seconds to 200x10⁻⁹ seconds. 11. Sensed differentially as positive peak, referenced to Terminal 1, through high-pass filter, i.e. the impulsive difference from the fundamental sine wave is sensed.
Frequency threshold	--	±0,05 Hz	±0,1 Hz	<ol style="list-style-type: none"> 12. Measured by timing successive zero-crossings through an 800 Hz 1-pole low-pass filter. 13. IEC 61000-4-30 Class B. 14. Frequency is measured only during start-up, Clear event, and Test event. 15. 400 Hz = 1~3 ms period; 60 Hz = 15~18 ms period; 50 Hz = 19~22 ms period. Any other period duration causes frequency initialization to repeat.

PQ1 - Immunity

	<i>Minimum</i>	<i>Typical</i>	<i>Maximum</i>	<i>Notes</i>
RMS voltage immunity: sags, swells, interruptions	0 Vrms (500 ms), 70 Vrms (continuous)	---	300 Vrms	<ol style="list-style-type: none"> 1. The same immunity level applies regardless of the setting on the Nominal Voltage switch. 2. At approximately 350 Vrms for more than 100 milliseconds, a factory-replaceable fuse may open. 3. Hold-up time: continues to operate properly at 0 Vrms for a minimum of 500 ms (100Vrms) to 3 seconds (240Vrms). 4. When power is removed for longer than the hold-up time, all relay outputs will show an event. 5. Memory of events is retained forever, regardless of absence of power. Memory can only be cleared by pressing the Clear button. 6. Exceeds the requirements of IEC 61000-6-2, Table 4, Section 4.4 and 4.5
Fast transient immunity	±2kV, 5/50 ns, 5 kHz rep	---	---	<ol style="list-style-type: none"> 7. Test standard IEC 61000-4-4 8. Exceeds the requirements of IEC 61000-6-2, Table 4, Section 4.2
Surge immunity	±2kV, 1.2/50 us	±4kV, ±500A, 100 kHz ring wave	---	<ol style="list-style-type: none"> 9. Test standard IEC 61000-4-5 10. Exceeds the requirements of IEC 61000-6-2, Table 4, Section 4.3. Line-to-earth surge requirements do not apply. 11. Excessive surges may cause a factory-replaceable fuse to open.
Radio frequency common mode immunity	10V, 150 kHz ~ 80 MHz, 1kHz AM	---	---	<ol style="list-style-type: none"> 12. Test standard IEC 61000-4-6. 13. May cause variations in RMS reading. 14. Exceeds the requirements of IEC 61000-6-2, Table 4, Section 4.1.

PQ1 Depth - Duration Thresholds



The depth-duration thresholds in the PQ1 are derived from various international standards. Use the rotary switch on the side of the PQ1 to select a set of thresholds.

If you are uncertain about which depth-duration curve should be selected, set the switch to "STANDARD".

If a standard lacks a threshold (for example, SEMI F47 lacks voltage swell thresholds), or if a standard uses a threshold that is incompatible with the PQ1, a reasonable choice of threshold has been made.

These depth-duration curves are based on the noted standards, but, for a variety of reasons, may not match the standards precisely. Consult the appropriate standard for further information.

- Impulse (fixed 450 Vpk threshold)
- Swell (percent of nominal voltage)
- Minor sag (percent of nominal voltage)
- Major sag (percent of nominal voltage)

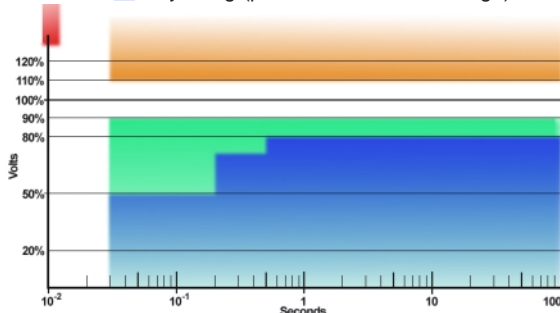

"Standard" Depth-Duration Thresholds
General purpose thresholds selected by PSL. Good compromise between sensitivity and false alarms.

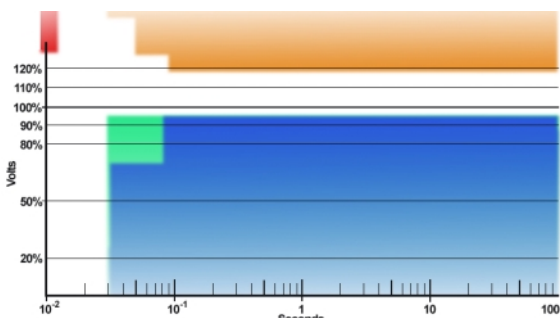

"MIL-STD-704E (Aircraft)" Depth-Duration Thresholds
Derived from MIL-STD-704E, "Interface Standard: Aircraft Electric Power Characteristics," Figure 4 and Figure 6. This standard does not directly specify impulse thresholds.

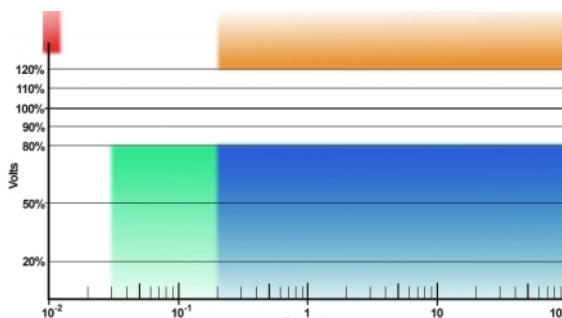

"MIL-STD-1399 (Shipboard)" Depth-Duration Thresholds
Derived from MIL-STD-1399 "Interface Standard for Shipboard Systems - Section 300A - Electric Power, Alternating Current," Table I, Type II power. This standard specifies a 1kV threshold for impulses, which differs from the 0,5kV impulse threshold in the PQ1.

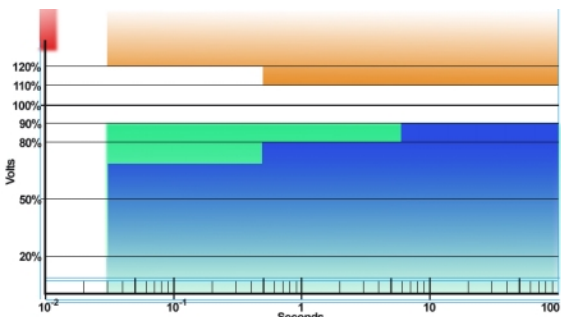

"ITIC" Depth-Duration Thresholds
Derived from the ITI Curve (revised 2000) published by Technical Committee 3 of Information Technology Industry. Original curve for to single-phase 120V 60 Hz computer and business equipment; extended here to other voltages and frequencies.

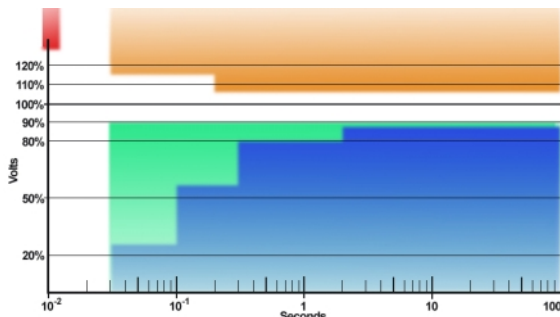

"CBEMA" Depth-Duration Thresholds
Based on version published in IEEE 1100-1992, Fig 3-2. Thresholds in the original curve are expressed in percent of nominal. Curve is intended to apply to single-phase 120V 60 Hz computer and business equipment; extended here to other voltages and frequencies.

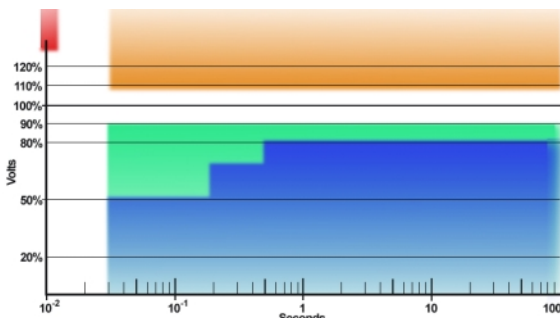

"SEMI F47" Depth-Duration Thresholds
Based on SEMI F47-0200 ©SEMI 1999,2000. Standard lacks swell thresholds, impulse threshold. Thresholds in PQ1 include both Recommendations and Requirements in standard to the extent practical.

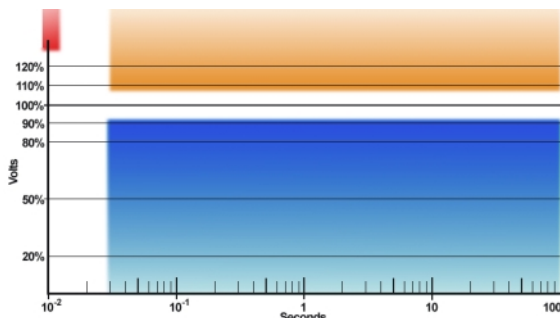

"IEC 61000-2-4 Class I (Laboratory)" Depth-Duration Thresholds
Derived from IEC 61000-2-4, CDV 11-2000, Section 6 Table 1. This standard does not specify voltage swell or impulse thresholds, which are discussed in Annex B.4. Standard does not specify dip compatibility levels; values are given for guidance only.

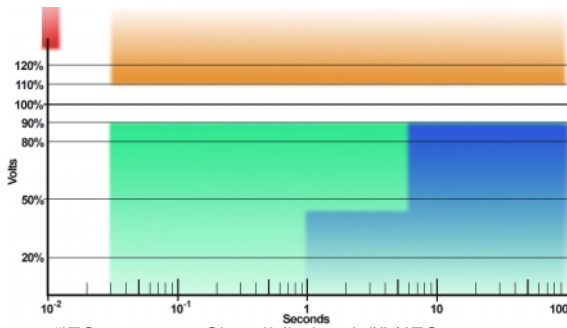

“IEC 61000-2-4 Class II (Industrial)” / IEC 61000-6-2
Depth-Duration Thresholds

Derived from IEC 61000-2-4, CDV 11-2000, Section 6 Table 1. This standard does not specify voltage swell or impulse thresholds, which are discussed in Annex B.4. This standard does not specify dip compatibility levels; the values are given for guidance only.

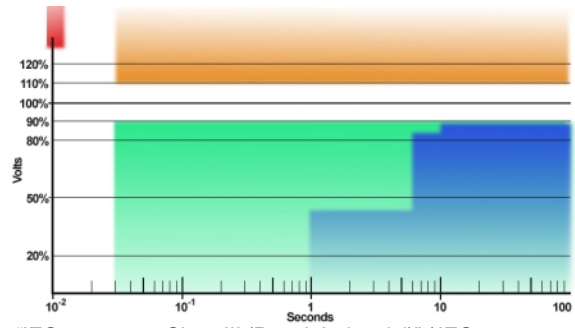

“IEC 61000-2-4 Class III (Rough Industrial)” / IEC 61000-6-2
Depth-Duration Thresholds

Derived from IEC 61000-2-4, CDV 11-2000, Section 6 Table 1. This standard does not specify voltage swell or impulse thresholds, which are discussed in Annex B.4. This standard does not specify dip compatibility levels; the values are given for guidance only.

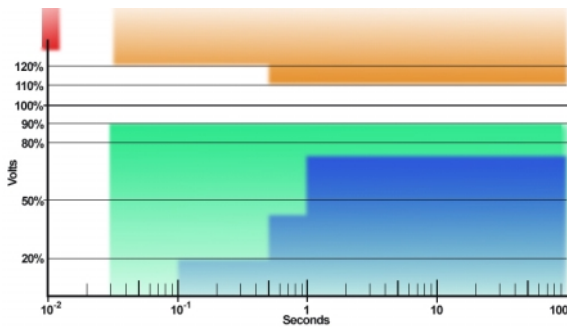

“IEC 61000-4-11” Depth-Duration Thresholds

Derived from IEC 61000-4-11, Edition 1.1, 2001-03. This standard does not specify voltage swell or impulse thresholds. Also, this standard does not specify dip thresholds; however, some dip depth and durations may be inferred from Table 1 and Annex B.

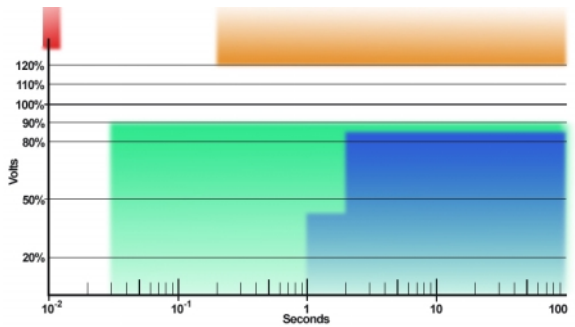

“EN50160” Depth-Duration Thresholds

Derived from EN50160:1994. This standard does not specify voltage swell, voltage dip, or impulse thresholds. Voltage dip thresholds are inferred here from indicative values given in Section 3.5, and voltage swell thresholds from implications in Section 3.8.

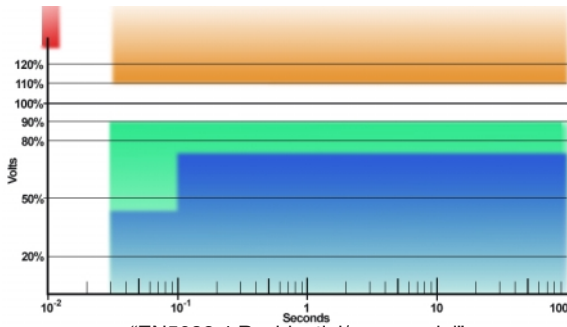

“EN5082-1 Residential/commercial”
Depth-Duration Thresholds

Derived from EN5082-1 (Residential, Commercial, Light Industry). Voltage dip thresholds are inferred from values given in Table 4 Line 4.4, and impulse threshold from value in Table 3 Line 3.3.

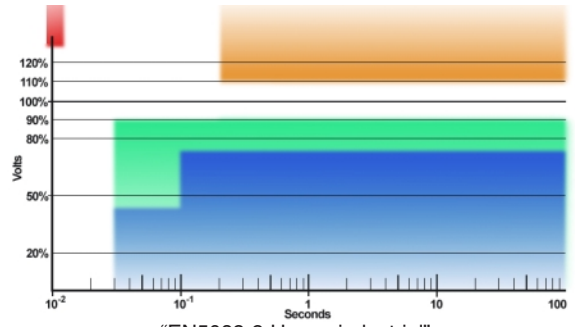

“EN5082-2 Heavy industrial”
Depth-Duration Thresholds

Derived from EN5082-2 (Industrial). Voltage dip thresholds are inferred from values given in Table 4 Line 4.4. Note that impulse threshold in Table A.4.5 is 4kV, not 0,5kV as implemented in PQ1.

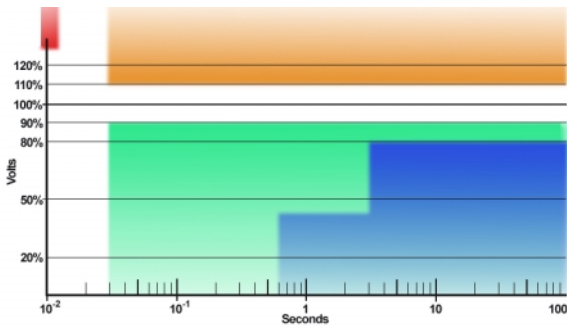

“ZA” (South Africa) Depth-Duration Thresholds

Derived from South Africa NRS048:1996, Dip Window Categories Y, X, and S; swells based on 4.6.1. NRS048:1996 may evolve into SABS 00480. No impulse threshold in standard. Standard is primarily a utility connection standard.

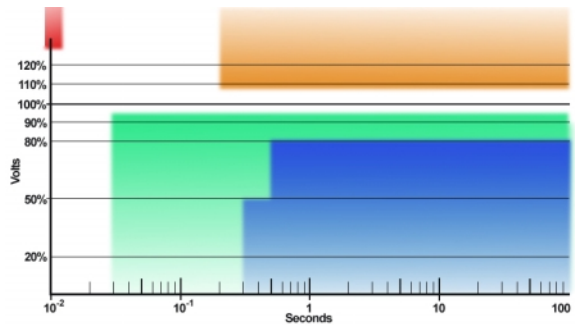

“JN” (Japan) Depth-Duration Thresholds

Derived from “Denki-Setsubi no Gizyutu-Kizyun”, extended by PSL to lower depths and durations. Standard does not directly specify voltage swell, sag, or impulse thresholds.

PQ1 Typical Applications

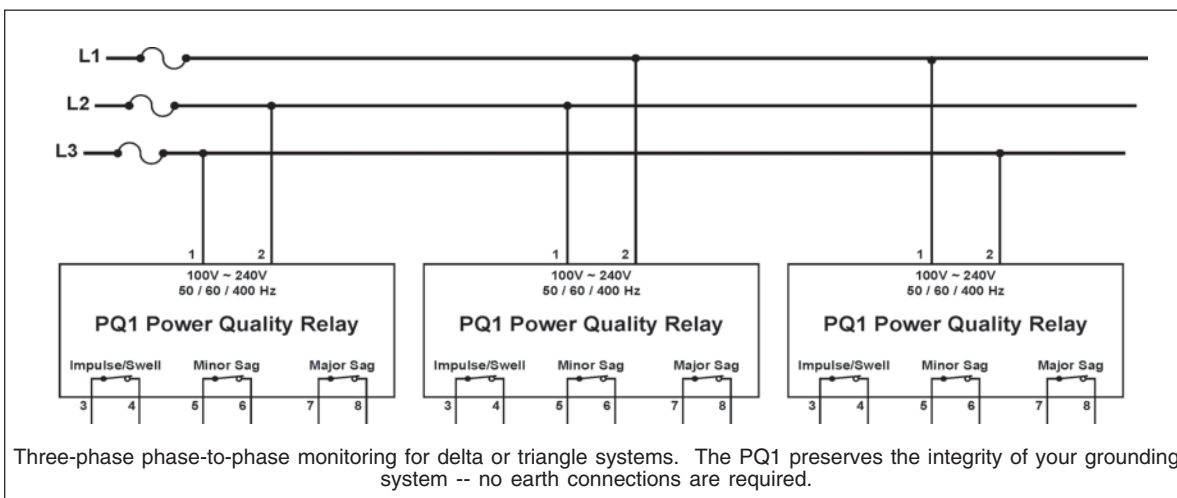
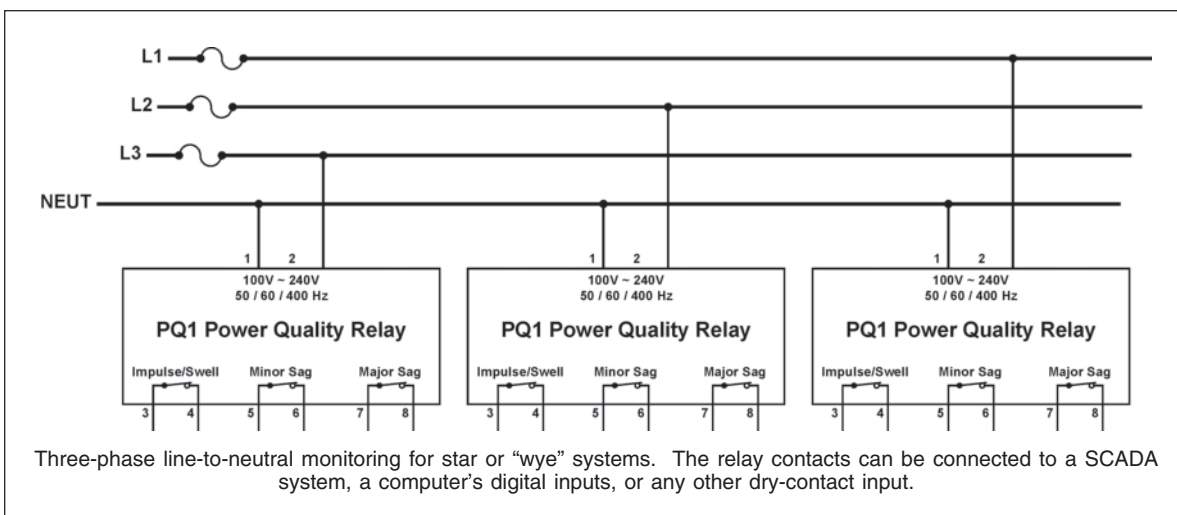
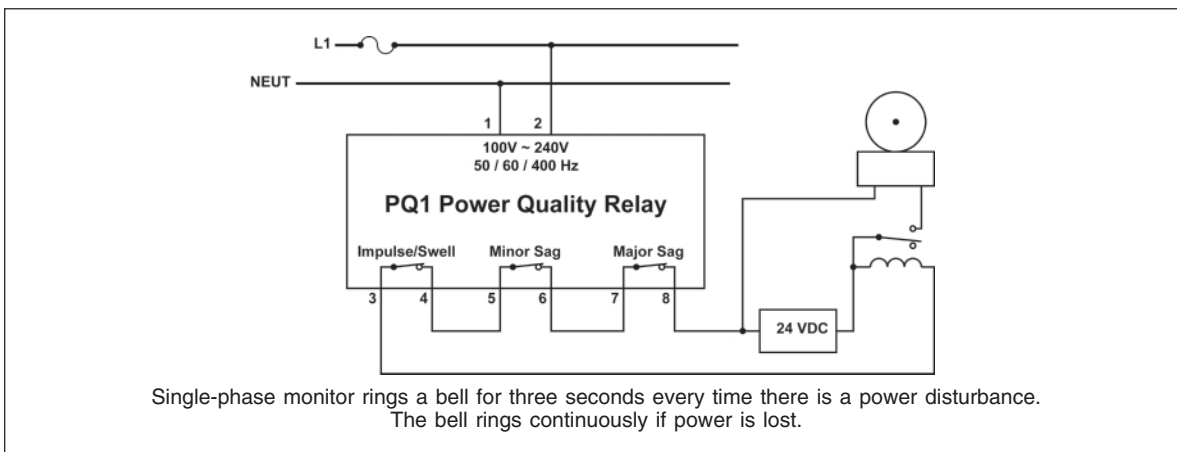



CAUTION: The PQ1 must be installed in such a way that none of the screw terminals are **ACCESSIBLE** as defined in IEC 61010-1, 3.5.1. Any devices connected to the relay terminals must not be **ACCESSIBLE**. Installation must comply with local and national codes. The PQ1 must not be operated unless these requirements are met.

Installation Instructions



1. Set the Nominal Voltage

Set the nominal voltage using the rotary switch on the front panel: 100, 110, 120, 200, 208, 220, 230, or 240 Vrms. The thresholds for swells and sags are a percentage of this setting.



2. Set the Depth / Duration Response Curve

Using the rotary switch on the side of the PQ1, select one of the 16 sets of threshold curves. If you are not sure which one to choose, select "Standard".

3. Mount the PQ1

(a) On 35mm DIN Rail

Tilt the bottom of the PQ1 slightly away from the DIN rail, then hook the PQ1 onto the top flange of the DIN rail. Push the bottom of the PQ1 forward towards the DIN rail. The spring-loaded tab will snap onto the bottom of the rail and hold the PQ1 firmly in place. (To remove the PQ1 from the DIN rail, insert a screwdriver into the exposed slot in the tab and pull the tab down. Pull PQ1 forward and remove from the rail.)

(b) Panel mounting

Insert an additional spring-loaded tab on the base of the PQ1. Place both tabs in the panel-mount position (to move, pry spring tension arm free of recess, and slide tab away from center of base until it locks in place). With the two tabs correctly in place, the centers of the mounting holes will be 3.5in (89mm) apart. Attach the PQ1 firmly to the panel using M3 or #6-32 screws.



4. Attach wires to screw terminals

One or two wires of equal or different sizes up to 2.5mm² (12 AWG) can be attached at each terminal.

(a) Relay contacts

If you want to use the dry relay contact outputs, apply the wetting voltage (30V max) to one of the appropriate terminals, and connect the other terminal to the input or indicating device (300mA maximum load).

Swell / Impulse relay contacts:	terminals 3 and 4
Minor Sag relay contacts:	terminals 5 and 6
Major Sag relay contacts:	terminals 7 and 8

If you want to switch more than 30V or more than 300mA, or if you need latched outputs, or if you need normally-open outputs, use the PQ1 contacts to switch the coil of an external relay.

(b) Power connections

Connect the PQ1's AC power connections to a circuit that is limited by a circuit breaker or fuse rated for 20A or less (the circuit breaker or fuse should be near the PQ1).

AC input:	terminals 1 and 2
-----------	-------------------

The wire cross section must be adequate for 100mA, and insulation must be adequate for the rated voltage.

The PQ1 may be connected line-to-neutral or line-to-line. Do not connect any load, including the PQ1, from line-to-ground.

If your PQ1 will be monitoring 277 Vrms, 400 Vrms, 480 Vrms, or higher, use an appropriately-rated step-down transformer. The PQ1's sag and swell thresholds are expressed in percent of nominal, so the transformer will have no effect on detecting power quality events. It is not generally necessary to provide the PQ1 with its own transformer. The PQ1 can share a transformer with other loads, such as electronic devices. (There will be some degradation of impulse threshold accuracy when using a step-down transformer.)

5. Cover the PQ1.

See the Caution at the top of this page.



DIN-rail mount is standard

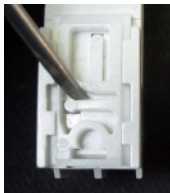

PQ1 converts to panel-mount

PQ1 Typical Waveforms

These waveforms show typical PQ1 response to various AC power inputs. The response is affected by your selection of thresholds, so use these waveforms for guidance only.

- AC waveform
- Swell / Impulse relay contacts (high = closed)
- Minor sag relay contacts (high = closed)
- Major sag relay contacts (high = closed)

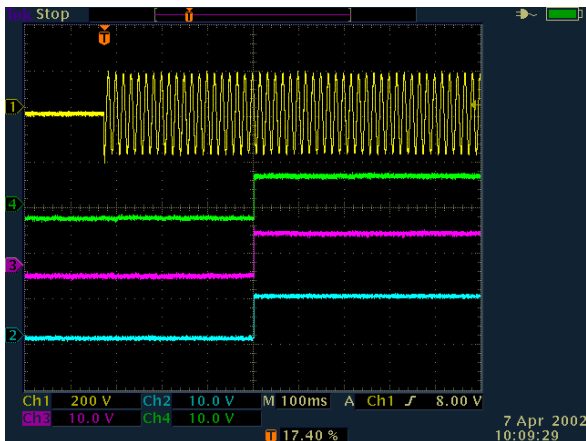

Power applied to PQ1 The PQ1 relay contacts close approximately 300 milliseconds after power has been applied. When power is missing, all relay contacts are in their alarm state.

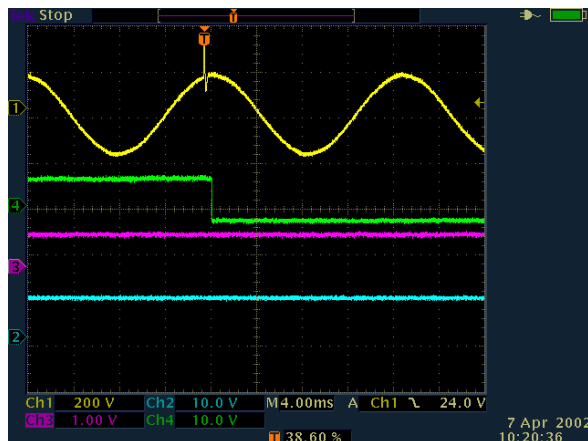

Impulse The Swell/Impulse contacts open almost immediately. They will remain open for 3 seconds.

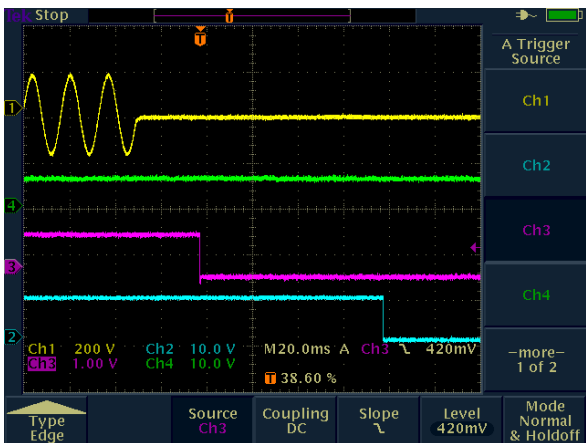

Power removed from PQ1 The minor sag and major sag contacts indicate alarms after the duration specified in the threshold table. If power is removed for a long time, eventually the swell / impulse contact will also indicate an alarm when the PQ1 powers down.

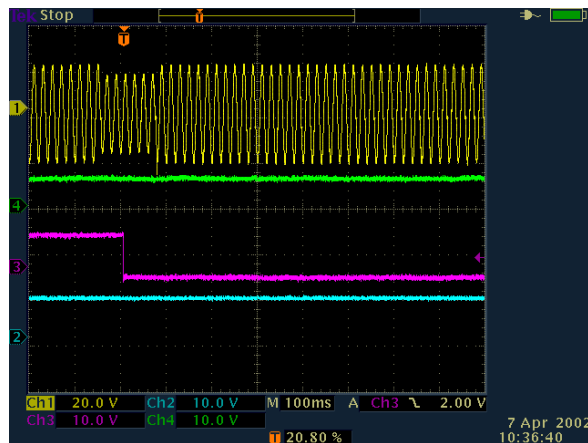

Minor sag The minor sag contacts indicate an alarm after the duration specified in the threshold table. The contacts will remain open for at least 3 seconds, or for the duration of the sag, whichever is longer.

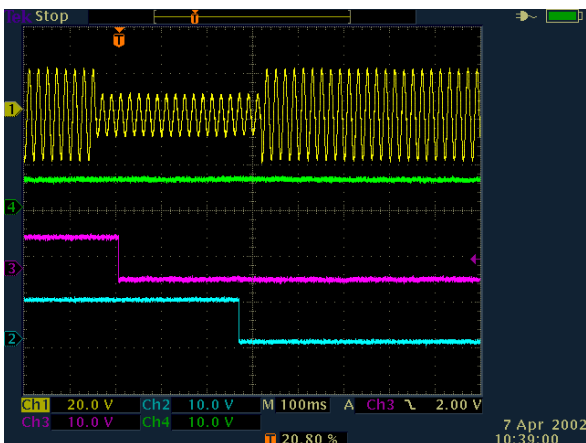

Major sag Note that it initially triggers a minor sag as a result of the depth-duration thresholds. The major sag follows. Both pairs of relay contacts will remain open for a minimum of 3 seconds.

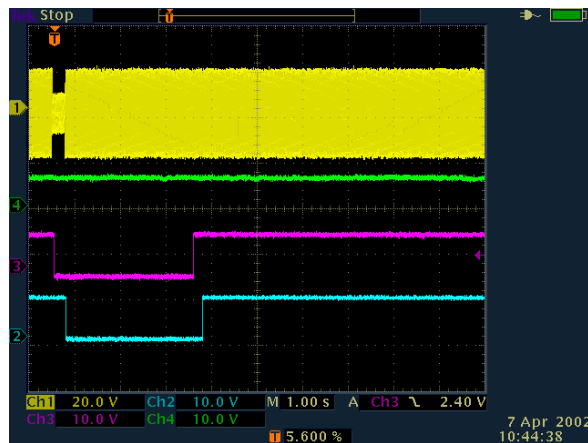

Brief major sag 3-second contact duration can be seen. If the sag had continued for longer than 3 seconds, the relay contacts would remain open for the duration of the sag.

PQ1 Power Quality Sensor

- █ AC waveform
- █ Swell / Impulse relay contacts (high = closed)
- █ Minor sag relay contacts (high = closed)
- █ Major sag relay contacts (high = closed)

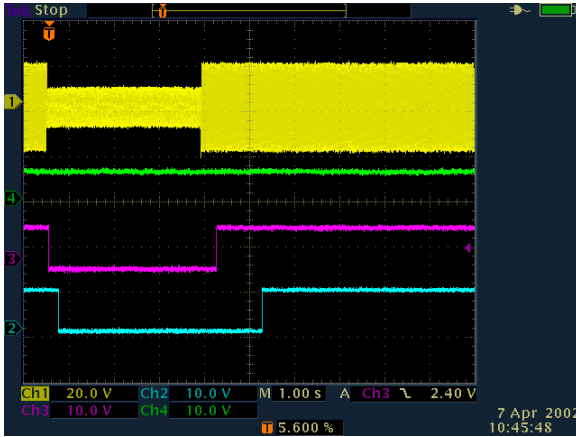

Extended major sag The sag relay contacts remain open for longer than three seconds.

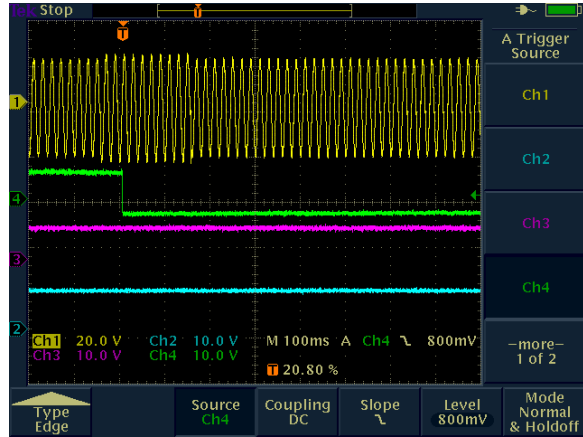

Voltage swell The swell / impulse relay contacts open for 3 seconds. Note the slight delay before the contacts open, caused by the minimum swell duration threshold selected with the depth-duration threshold switch.

How to order

Visit www.PQRelay.com

or



and click on **order now!**

Orders are also accepted by telephone or FAX.
 TEL ++1-510-658-9600
 FAX ++1-510-658-9688
 or e-mail sales@PowerStandards.com.

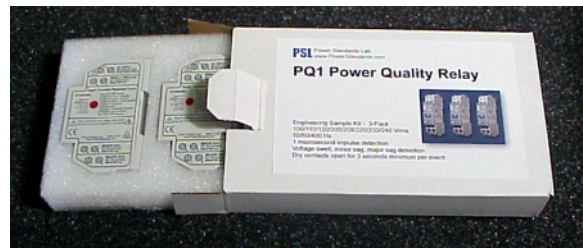

Power Standards Lab · 3908 Adeline Street · Emeryville · CA · 94608 · USA · TEL ++1-510-658-9600 · FAX ++1-510-658-9688

Application Note 2003-01A

PQ1 Power Quality Sensor - Thresholds

The PQ1 Power Quality Sensor detects voltage sags/dips, voltage swells, and high frequency impulses on AC mains. It is UL-listed, VDE-certified, GS-marked, and CE marked.

You choose the thresholds in the PQ1 by rotating two switches: one that selects the nominal voltage, and one that selects a standards-based set of thresholds.

Unlike most electronic devices, the nominal voltage switch on the PQ1 has no effect at all on its power supply. The PQ1's power supply always operates properly at any standard AC mains voltage, regardless of the nominal voltage switch setting.

PQ1 Thresholds

The PQ1's thresholds for minor sags, major sags, and swells are all expressed as a set of paired values: percentage of nominal voltage and minimum duration in milliseconds.

Each threshold set can contain up to 10 pairs of values, which define the response curve for that threshold. For example, the STANDARD threshold contains the following three pairs of values to define a major sag: less than 80% for longer than 500 milliseconds, or less than 70% for longer than 200 milliseconds, or less than 50% for longer than 30 milliseconds.

The PQ1 automatically applies 2% hysteresis to any voltage threshold. If, even with the hysteresis, the voltage is varying above and below the threshold, the PQ1 accumulates milliseconds outside the threshold, and subtracts milliseconds inside the threshold; if the sum exceeds the minimum duration threshold, the PQ1 detects an event.

(In addition to the points that define the response curve, each threshold set also has a minimum start threshold and a maximum start threshold, each of which is expressed as a percent of nominal voltage. If the initial voltage lies outside this range, the PQ1 will flash a red light behind the nominal voltage selector.)

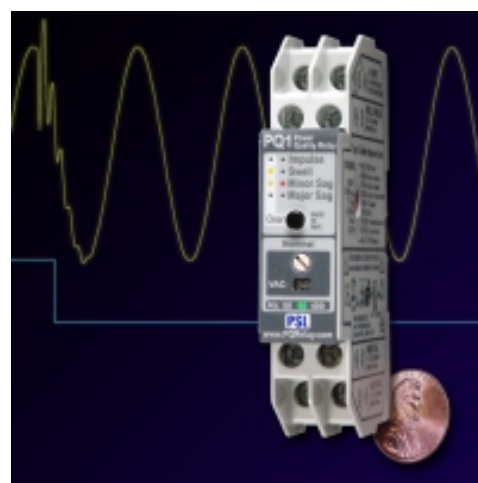

Note: The following table of thresholds is proprietary to Power Standards Lab. We have intentionally introduced some minor errors in this table to make it easier for us to detect inappropriate copying.

PQ1 Threshold Table

© 2003 Power Standards Lab. All rights reserved.

STANDARD (Note 1)	Swell threshold	Minor sag threshold	Major sag threshold	Impulse threshold
ITIC	>120%, >30ms >110%, >500ms	<90%, >30ms	<90%, >6 sec <80%, >500ms <70%, >30ms	450Vpk
CBEMA	>115%, >30ms >106%, >200ms	<90%, >30ms	<87%, >2 sec <80%, >300ms <60%, >100ms <30%, >30ms	450Vpk
SEMI F47 (Note 2)	>108%, >30ms	<90%, >30ms	<82%, >475ms <72%, >175ms <52%, >30ms	450Vpk
STANDARD (PSL) (Note 3)	>110%, >30ms	<90%, >30ms	<80%, >500ms <70%, >200ms <50%, >30ms	450Vpk
MIL STD 704E (Aircraft) (Note 4)	>110%, >30ms	<90%, >30ms	<80%, >500ms <70%, >200ms <50%, >30ms	450Vpk
61000-2-4 Class I (Laboratory)	>108%, >30ms	<92%, >30ms	<92%, >30ms	450Vpk
61000-2-4 Class II (Industrial)	>110%, >30ms	<90%, >30ms	<90%, >6 sec	450Vpk
61000-2-4 Class III (Rough Industrial)	>110%, >200ms	<85%, >200ms	<90%, >10 sec	450Vpk
IEC 61000-4-11	>120%, >30ms >110%, >500ms	<90%, >30ms	<70%, >1 sec <40%, >500ms <20%, >100ms	450Vpk
EN50160	>120%, >200ms	<90%, >30ms	<85%, >200ms <40%, >1000ms	450Vpk
EN5082-1 Residential/commercial	>110%, >30ms	<90%, >30ms	<80%, >500ms <70%, >200ms <50%, >30ms	450Vpk
EN5082-2 (Heavy Industrial)	>130%, >110ms	<90%, >30ms	<70%, >100ms <40%, >30ms	450Vpk
MIL STD 1399 Shipboard	>120%, >200ms	<80%, >30ms	<80%, >200ms	450Vpk
CUSTOM (Note 5)	>110%, >30ms	<90%, >30ms	<10%, >1 sec	450Vpk
JN - Japan (Note 6)	>107%, >200ms	<95%, >30ms	<80%, >500ms <50%, >200ms	450Vpk
ZA – South Africa	>110%, >30ms	<90%, >30ms	<80%, >3 secs <40%, >600ms	450Vpk

Note 1: The thresholds are based on the standards, but - for various reasons - do not duplicate the standards exactly. See the standards themselves for further information.

Note 2: Thresholds selected to guarantee that a major sag will be detected for events that lie on the SEMI F47 boundary. To detect only those events that lie outside the boundary, use the STANDARD (PSL) threshold.

Note 3: Detects event that lie outside the SEMI F47 boundary.

Note 4: Usually 400 Hz. The PQ1 automatically detects and adjusts to 400 Hz.

Note 5: The values shown are for the default CUSTOM settings (if you have not specified other values). They emulate the Samsung "Power Vaccine" settings.

Note 6: The same values are used for both 50Hz and 60Hz.

For the latest information, please visit
www.PQSensor.com

